

Glacier Transportable Sampler

This pocket guide is not intended to replace the instruction manual provided on CD. Read the *Glacier Manual on CD* thoroughly before operating the sampler.

COPYRIGHT © 2002 by
Teledyne Isco, 4700 Superior St., Lincoln,
Nebraska, U.S.A. 68504
Phone: (402) 464-0231
Toll Free: (866) 298-6174
FAX: (402) 465-3022

Part #69-2963-018
Revision C, March 2012

Glacier Transportable Sampler

Table of Contents

1. Introduction

- 1.1 General Safety 1-1
 - 1.1.1 Electrical Requirements 1-1
 - 1.1.2 General Warnings 1-2
- 1.2 Typical Applications 1-3
 - 1.2.1 Compatible Equipment 1-3
- 1.3 Glacier Features 1-4

2. Installation

- 2.1 Installation Checklist 2-1
- 2.2 Positioning the Sampler 2-2
- 2.3 Replacing the Pump Tube 2-5
 - 2.3.1 Pump Tube Warning 2-6
 - 2.3.2 Visual Inspection 2-6
- 2.4 Install the Bottle 2-7
- 2.5 Insert the Temperature Sensor into the
Bottle 2-10
- 2.6 Route the Discharge Tube 2-11
- 2.7 Connect a Power Source 2-11
 - 2.7.1 Battery Recommendations . . 2-13
- 2.8 Connect a Suction Line and Strainer . . .
2-14
 - 2.8.1 Route the Suction Line and
Strainer 2-15
- 2.9 External Connections 2-16

2.10 Calibrate the Sample Volumes 2-17

3. Programming

3.1 Programming Overview 3-1

3.2 The Glacier Interface 3-2

 3.2.1 The Glacier Display 3-2

 3.2.2 The Glacier Keypad 3-2

3.3 Glacier Operating States 3-2

 3.3.1 Interactive States 3-3

 3.3.2 Non-interactive States 3-3

3.4 Programming the Glacier 3-4

3.5 One-button Programming 3-4

 3.5.1 Stored Program 3-5

3.6 Standard Programming 3-6

 3.6.1 Programming Step 1 – Pacing 3-7

 3.6.2 Programming Step 2 – Pacing
 Interval 3-7

 3.6.3 Programming Step 3 – Bottle
 Volume 3-8

 3.6.4 Programming Step 4 – Number of
 Samples 3-11

 3.6.5 Programming Step 5 – Sample
 Volume 3-12

 3.6.6 Programming Step 6 – Delay to
 First Sample 3-12

 3.6.7 Programming Step 7 – Calibrate
 Sample Volumes 3-13

3.7 Setting the Time and Date 3-14

3.8 Glacier Options 3-15

 3.8.1 Program Lock 3-16

 3.8.2 Storing a Program 3-19

 3.8.3 Disable Bottle Full Detection 3-20

 3.8.4 Liquid Detector Disable 3-20

 3.8.5 Foreign Language Displays . 3-21

4. Operation

4.1 Overview 4-1

4.2 Starting a Program 4-2

4.3 Counting Down Delay Times 4-2

4.4	Sampler Inhibit	4-3
4.5	Run State Displays	4-4
4.5.1	Collecting a sample –	4-4
4.5.2	Waiting to sample –	4-5
4.5.3	Errors –	4-5
4.6	Sample Collection Cycle	4-6
4.6.1	Pre-purge	4-6
4.6.2	Fill	4-6
4.6.3	Post-purge	4-7
4.7	Refrigeration Control	4-7
4.8	Pausing or Stopping a Program	4-8
4.9	Program Completion	4-9
4.10	Post-sampling Activities	4-9
4.10.1	Recovering the Sampler	4-9
4.10.2	Preparing the Full Sample Bottle	4-10
4.11	Log	4-10
4.11.1	Errors	4-13
4.11.2	Viewing Log Reports using Isco SAMPLINK software	4-14
4.11.3	Viewing Log Reports using a Terminal Program	4-15
4.12	Grab Samples	4-16

5. Maintenance

5.1	Overview	5-1
5.2	Cleaning	5-2
5.2.1	Cleaning the Glacier Exterior	5-2
5.2.2	Cleaning the Bottles	5-2
5.2.3	Cleaning the Suction Line and Tubing	5-3
5.2.4	Cleaning the Temperature Sensor	5-3
5.3	Defrosting the Glacier Refrigerated Compartment	5-4
5.4	Replacing the Pump Tube	5-4
5.4.1	Removing the Tube	5-5
5.4.2	Replacing the Tube	5-7
5.4.3	Resetting the Pump Tube	

Warning	5-8
5.4.4 Optimizing Pump Performance ..	5-8
5.5 Replacing the Discharge Tube	5-9
5.6 Servicing Batteries	5-11
5.7 Replacing the Internal Desiccant ..	5-12
5.8 Glacier Troubleshooting	5-12
5.9 Contacting Teledyne Isco for Assistance	5-13
5.10 Other <i>Glacier Manual on CD</i> resources .	5-14

Glacier Transportable Sampler

Section 1 Introduction

1.1 General Safety

Do not use this product with any other manufacturers' equipment, or for any other purpose. Use for any purpose not described in this manual could cause personal injury or property damage.

1.1.1 Electrical Requirements

The Glacier requires 12 VDC at 6 amperes. The DC power input is through the two-pin connector on the side of the refrigerated compartment. The Isco-supplied DC connect cables provide over-current protection through the use of an in-line 8A, 32V fuse. The dual-power configuration of the Glacier may also be powered by an 87 to 264 VAC, 47 to 63 Hz, 2 ampere power source using the attached AC line cord. The AC-powered Glacier is protected by an internal thermal cut-out. Additionally, the controller circuitry is protected by an internal 3.75 ampere PTC (Positive Temperature Coefficient) device.



Electrocution hazard. Never manipulate electrical switches or power connections with wet hands or when your feet are in contact with water.



**Dual-power units only:
AC electrical power must meet the applicable electrical code requirements for your installation. If necessary, consult with a certified electrician to ensure that AC power is provided in accordance with the local electrical code.**

1.1.2 General Warnings

Before installing, operating, or maintaining this equipment, it is imperative that all hazards and preventive measures are fully understood. While specific hazards may vary according to location and application, take heed in the following general warnings:



Avoid hazardous practices! If you use this instrument in any way not specified in this manual, the protection provided by the instrument may be impaired.

1.2 Typical Applications

The Glacier is part of Isco's many automated sampling solutions which include the Model 3700 and 6700 Series samplers. This versatile product line meets the demands of:

- NPDES permit compliance
- Pre-treatment compliance
- Stormwater run-off
- Combined sewer overflow
- Sanitary sewer evaluations
- Non-point source sampling
- Biomonitoring

1.2.1 Compatible Equipment

Compatible Isco devices include:

Isco flow measuring instruments:

- 4100 Series Flow Loggers
- 4200 Series Flow Meters

Non-Isco device interfaces:

- 4-20 mA Input Interface
- Pulse Duration Input Interface

Isco parameter measuring devices:

- Liquid Level Actuator

1.3 Glacier Features

Figure 1-1 Glacier Features

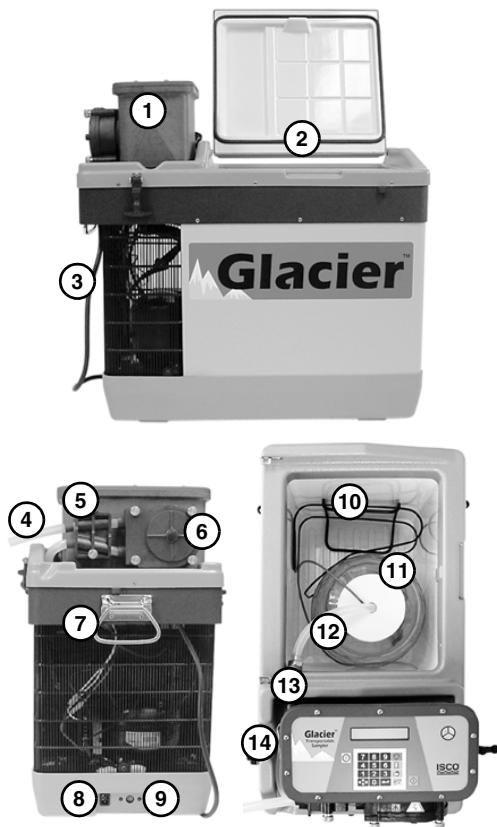

- 1 Sampler Controller
 - 2 Refrigerated Compartment
 - 3 AC Power Cable
(Dual-power Models only)
 - 4 Pump Tube
 - 5 Liquid Detector
 - 6 Pump Housing
 - 7 Carrying handle
 - 8 DC Power connector
 - 9 Power mode switch.
Always LOW.
 - 10 Sample Bottle Retainer
 - 11 Sample Bottle
 - 12 Discharge Tube
 - 13 Bulkhead fitting
 - 14 Flow meter connector
-

Figure 1-2 Glacier Control Panel Buttons



From the Off state, the *Standby* button turns the Glacier on and places it in the Standby state. In any other state, the Standby button will place the sampler in the Off state.



NUMBER buttons allow you to enter numerical values when prompted by an interactive screen.



The *ARROW* button changes the current selection in an interactive screen. Pressing the *ARROW* button causes a different option to blink.



In an interactive state, the *ENTER* button accepts the selected (blinking) option. In non-interactive states, pressing the *ENTER* button will scroll through any additional displays.



The *STOP* button interrupts the current task and the display reverts to the previous screen or state. If you press the *STOP* button while a number-entry screen is displayed, the Glacier restores the previous value. Pressing the *STOP* button during a running program places the Glacier in the Paused state.



Pressing the *CALIBRATE* button while in the Standby state takes you to the Calibrate Sample Volume sequence of the programming.



The *GRAB SAMPLE* button allows you to collect a grab sample outside of the programmed number of samples.



The *PROGRAM* button is used for the Glacier One-button Programming.



Pressing the *GO* button places the Glacier in the Run state using the current program.

Glacier Transportable Sampler

Section 2 Installation

2.1 Installation Checklist

- Place the Glacier Sampler in position
- Inspect the pump tube
- Install the bottle
- Insert the temperature sensor into the bottle
- Check the discharge tube
- Connect a power source
- Connect a suction line and strainer
- External connections (essential for flow-paced sampling or sampler inhibiting)
- Calibrate sample volumes (optional)
- Start the Program
- Secure the Glacier

2.2 Positioning the Sampler

There are a few considerations when selecting a site for the Glacier sampler. The foremost concern should be personal safety.



WARNING

The installation and use of this product may subject you to hazardous working conditions that can cause you serious or fatal injuries. Take any necessary precautions before entering the worksite. Install and operate this product in accordance with all applicable safety and health regulations, and local ordinances.



WARNING

If this product is used in a manner not specified in this manual, the protection provided by the equipment may be impaired.

The following points should also be considered:

- *Power* – The only means to totally remove power from the Glacier is by disconnecting the mains line cord from the power outlet, or the cable to the battery.



CAUTION

Position the battery or connect to the mains outlet in a location where power may be disconnected easily in an emergency.

- *Level surface* – The Glacier should be placed on a level surface to prevent tipping or spills.

**CAUTION**

Positions other than the Glacier's normal upright position will drain the lubricant away from the refrigerator compressor. Operation without adequate lubrication may permanently damage the refrigeration system. If the Glacier is turned over for more than a few seconds, the Glacier's refrigeration system must not be operated for at least one hour after returning the Glacier to its upright position.

- *Support* – The surface must be able to support the Glacier at full capacity. This weight would include the Glacier, the full sample bottle, and the battery (if used).
- *Ventilation* – The Glacier requires at least 1 foot (0.3 m) of air space around the refrigeration components. The Glacier's refrigeration system does not have an evaporator fan. Instead, it relies on air circulation to dissipate the heat removed from the refrigerated compartment. Inadequate ventilation will reduce the cooling capacity and significantly increase power consumption.
- *Environmental* – The Glacier is designed for use in harsh environments. However, you should avoid installing the Glacier where it may be subjected to chemical attack. Also, prolonged exposure to direct

sunlight will eventually damage the exterior. If the Glacier is subject to chemical attack or prolonged UV exposure, consider using a protective enclosure. Keep in mind that positioning the Glacier in direct sunlight will also increase power consumption, a factor worth considering when using battery power.

- *Avoid submersion* – Although the controller will resist damage (rated NEMA 4x, 6), the refrigerator system and bottle compartment cannot prevent the liquid from entering. Liquid entering the refrigerated system will damage the cooling system; liquid entering the bottle compartment will contaminate the collected samples.
- *Accessibility* – The Glacier must be installed in a location where it can be recovered easily without tipping or difficult maneuvering.
- *Security* – The location may need to provide some degree of security to prevent tampering or vandalism. Some methods you can employ are:
 - using the Program Lock (see 3.8).
 - preventing access to the controller and refrigerated compartments by using the Glacier Locking Kit, Isco P/N 68-2960-011.
 - Securing the Glacier to an immovable object using a bicycle locking cable.

2.3 Replacing the Pump Tube

If your sampling protocol mandates that you replace the pump tube for each sampling program, refer to the replacement instructions in section 5.4. Otherwise, the pump tube can remain until one of the two following conditions are present:

- The sampler controller displays a pump tube warning, or —
- A pre-sampling program visual inspection identifies a worn or damaged tube.

The pump tube must be replaced when the first of either condition exists.

The importance of regular tubing replacement cannot be overstated. The key is to replace the tube before failure, not after. When a pump tube ruptures, grit and other abrasive debris can be driven into the pump shaft seal. Over time, this abrasive material will degrade the pump seal, jeopardizing the NEMA 4x 6 rating of the controller.

 Note

Failure to maintain the pump tube may result in permanent damage to the sampler. Check the condition of the pump tube regularly and if the tube shows signs of fatigue or wear, replace it immediately. A properly maintained sampler will provide years of reliable service that is expected of an Isco Sampler.

Section 5.4 of this guide describes the pump tube removal and replacement steps. Afterwards, be sure to reset the pump counter (5.4.3).

2.3.1 Pump Tube Warning

The Glacier displays a pump tube warning at the recommended replacement interval. The warning display will alternate with the run screens, and is part of the VIEW LOG screens. Regardless of the visual condition of the pump tube, it should be replaced as soon as possible after the warning.

The warning appears after the controller reaches the factory set value of 500,000 pump counts. This value will deliver approximately 500 samples of 200 ml each, using a $\frac{3}{8}$ -inch by 10-foot suction line at a 5-foot suction head. The pump tube replacement interval of 500,000 pump counts should be sufficient for most applications. If you are sampling abrasive liquids or liquids with a high content of suspended solids, you may find that the pump tube requires replacement more frequently.

2.3.2 Visual Inspection

The pump tube must be inspected before running each program. Pump tube failures can prevent the Glacier from collecting the samples—or worse—may even damage the controller.

To inspect the pump tube:



CAUTION

Moving parts can cause injuries. Remove power before inspecting pump tube.

1. Disconnect the power from the Glacier.

2. Remove the pump housing cover by loosening the four thumbscrews.
3. Visually inspect the pump tube for cracks where it is compressed by the rollers. If the tube is cracked, it must be replaced. Section 5.4 provides detailed instructions on replacing the pump tube and resetting the pump tube counter.
4. Visually inspect the inside of the pump housing. The housing and rollers should be free from debris.
5. Replace the pump housing cover and tighten the thumbscrews.

2.4 Install the Bottle

The base section of the Glacier is designed to hold five different types of bottles. These bottle options are shown in Table 2-1.

The bottle fits inside the refrigerated compartment of the Glacier and is secured by the bottle retainer. Refer to Figure 2-1 for the correct placement of the bottle and retainer.

Attach the cap with the center hole to the bottle opening. The cap without the hole is for transporting the full bottle. You may store this inside the refrigerated compartment for later use.

Note that the program volume listed in Table 2-1 is slightly less than the nominal bottle volume. The smaller program volume prevents the bottle from being over-filled. Refer to Section 3.6.3 for more information on bottle volumes.

Table 2-1 Standard Bottle Sizes

Part Number	Program Volume (in ml)	Description
68-2960-008	19000	5-gallon (19-liter) lightweight polyethylene bottle with caps.
68-2960-005	9400	2.5-gallon (10-liter) Nalgene polyethylene bottle with caps.
68-2960-006	9400	2.5-gallon (10-liter) Glass bottle with Teflon-lined caps.
68-2960-007	9400	2.5-gallon (10-liter) lightweight polyethylene bottle with caps.
68-2960-009	7000	2-gallon (9-liter) ProPak single-use liner with holder, caps and 100 liners.
<p>Bottle kits ordered with the part numbers above include two caps (one with a hole for the discharge tube and temperature sensor, the other without the hole for transporting), two discharge tubes, and a bottle retainer.</p>		

Figure 2-1 Bottle Placement

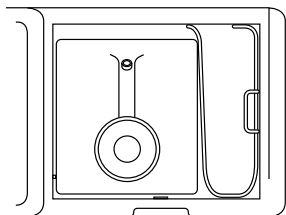

5-gallon (19-liter)
lightweight
polyethylene bottle
with narrow bottle
retainer
(69-2963-036)

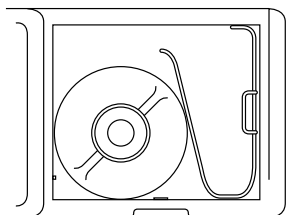

2.5-gallon (10-liter)
round bottles and
2.0-gallon (9-liter)
ProPaks
with narrow bottle
retainer
(69-2963-036)

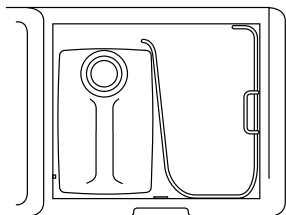

2.5-gallon (10-liter)
lightweight
polyethylene bottle
with wide bottle
retainer
(69-2963-035)

2.5 Insert the Temperature Sensor into the Bottle

To reliably cool the samples, the temperature sensor must be inserted into the bottle. The sensor should be routed through the hole in the bottle cap.

Note

When using the refrigeration control, the end of temperature sensor must be positioned at the bottom of the container. See Figure 2-2.

Your sampling protocol may require that the temperature sensor be cleaned before each sampling program. Refer to section 5.2.4 for cleaning instructions. Using a protective sleeve is a practical alternative to cleaning the temperature sensor. Teflon sleeves are part of a Priority Pollutant Sampling Kit. Call the factory for more information.

Figure 2-2 Temperature Sensor in Bottle



cut-away view of
2.5 gallon
lightweight
polyethylene
bottle

2.6 Route the Discharge Tube

The discharge tube is located inside the refrigerated compartment. The medical-grade Silastic™ tubing routes the liquid from the bulkhead fitting to the bottle. The 5-gallon and 2¹/₂-gallon lightweight polyethylene bottles use a 5¹/₄-inch long tube. The 2¹/₂-gallon Nalgene and glass bottles, and the ProPaks use an 11¹/₄-inch long tube.

The discharge tube should be well fitted over the bulkhead fitting and routed through the hole in the bottle cap. The tube must be free of twists or kinks.

 Note

The amount of tubing that should extend into the bottle will depend on the programmed sample volume (see section 3.6.3). For the bottle-full detection to work properly, the volume above the discharge tube end must be greater than the programmed sample volume.

The 5-gallon bottle is equipped with a barbed tubing port. Use this port only when bottle-full detection is not needed.

2.7 Connect a Power Source

The Glacier sampler is available with two power options. The dual-power option allows you to power the refrigerated sampler using AC (87–264 Volt, 47–63 Hz) or DC (12 Volt) power. The DC powered option can only be powered by a 12 VDC source.

To connect the dual-power Glacier to AC power, use the attached AC power cord. The dual-power Glacier may be ordered with a power cord for North American outlets, or with a power cord for most European outlets. Users in other regions will need to purchase an appropriate plug adapter for use with the available power outlets. Because the dual-power Glacier includes an internal universal AC power converter, only outlet adapters are required to configure the sampler for the power source. No other hardware or wiring changes are necessary.

To connect the (DC or dual-power) Glacier to a DC power source, use one of the supplied 12 VDC connect cables. Two types are shipped with the Glacier. Connect cable 60-2964-021 is used connect the Glacier to an automotive or deep-cycle marine battery with heavy-duty clips. Connect cable 480-0199-00 is used to connect the Glacier to a cigarette lighter outlet that provides 12 VDC power. Both cables provide over-current protection through the use of an in-line 8 amp Slo-Blo “T” fuse.

 CAUTION
--

Only use Isco battery cables 60-2964-021 or 480-0199-00 to connect the Glacier to a DC power source. The cable length and fusing protect you and the equipment from over-current conditions and the risk of fire.



CAUTION

Never use a DC extension cable without first consulting with an Isco Service Technician. They will advise you of the proper wire gauge for the length you require.

The refrigerator compressor is equipped with a battery controller that will cut out to protect the compressor and the battery when the voltage drops to 10.4 — 11.3 VDC. The controller will cut in at 11.7 — 12.5 VDC.



CAUTION

Never charge the battery while connected to the Glacier. Over-voltages could damage the electronics.

2.7.1 Battery Recommendations

Before each sampling program, the battery should be exchanged with a fully-charged battery.

Note that power consumption is mostly determined by the ambient temperature. Higher ambient temperatures will in turn create a higher demand for power. A battery selection guide is provided in the *Glacier Manual on CD* to help you determine the required battery capacity.

2.8 Connect a Suction Line and Strainer

The suction line carries the liquid from the sampling point to the Glacier pump tubing. The Glacier is designed to use:

- 1/4-inch (6-mm) I.D. Vinyl tubing
- 3/8-inch (9-mm) I.D. Vinyl tubing
- 3/8-inch (9-mm) I.D. Teflon[®] tubing with a protective polyethylene jacket

 Note

Selecting 1/4-inch (6-mm) suction line disables the Bottle Full detection.

The vinyl suction line does contain a very low ppm (parts per million) level of phenols. If this affects your samples, use the Teflon suction line.

The strainer reduces the possibility of debris plugging the suction line. Two types are available to choose from. Refer to the *Glacier Manual on CD*.

To prepare the suction line and strainer:

1. Cut the suction line to the shortest feasible length.

When cutting the suction line, keep in mind that the length must be cut to the nearest whole foot or decimeter. If you alter the length, measure the suction line from end to end. This measurement will be used when calibrating the sample volumes.

2. Attach a strainer to the suction line.
3. Connect the suction line to the pump tube.
4. Route the suction line and place the strainer in the liquid.

2.8.1 Route the Suction Line and Strainer

The strainer should be placed in the stream so that representative samples are collected. The intake should be in the main flow, not in an eddy or at the edge of flow. Its depth in the stream can also be important. An intake placed at the bottom of the stream may result in excess heavy solids, while placement at the top may result in the opposite.

Route the suction line so that it runs continuously downhill. Loops of coiled suction line or low areas where the liquid can pool will hold residual amounts of liquid that will cross-contaminate sample volumes. A consistent downhill slope will help eliminate air slugs in the line, increasing the sample-to-sample repeatability and accuracy.

The suction line will tend to float when sampling from deep flow streams. Refer to Table 2-2. If the depths listed in the table are exceeded, anchor the line securely so that the suction line and strainer do not become dislodged.

Table 2-2 Strainer/Suction Line Depths

Strainer	Vinyl 1/4-inch (6 mm)	Vinyl 3/8-inch (9 mm)	Teflon 3/8-inch (9 mm)
Stainless Steel	22 feet (6.7 m)	22 feet (6.7 m)	15 feet (4.5 m)
CPVC	—	4 feet (1.2 m)	—

2.9 External Connections

The Glacier can be used with external devices that control the sampler pacing, sampler inhibiting, or both. The sampler pacing input can control the rate of sample collection so that it is proportional to the flow rate of a channel. This input must be used when the Flow Paced program option is selected. The sampler inhibit input can delay the Glacier operation until a monitored parameter meets user-defined conditions.

These devices connect to the 6-pin Flow Meter Connector located on the side of the Glacier controller. Compatible Isco devices include:

Pacing and Inhibiting devices:

- 4100 Series Flow Loggers
- 4200 Series Flow Meters

Pacing devices (non-Isco device interfaces):

- 4-20 mA Input Interface
- Pulse Duration Input Interface

Inhibiting devices:

- Liquid Level Actuator

If you are connecting a device other than those listed above, refer to the *Glacier Manual on CD* for signal requirements.

2.10 Calibrate the Sample Volumes

The Glacier can deliver sample volumes repeatable to ± 10 ml. The sampler relies on you to enter correct suction line diameter and length values. The Glacier uses these values to:

- Generate internal pump tables to “measure” the liquid volume
- Calculate the suction head.

By calculating the suction head, the delivered volumes are not affected by varying liquid levels. The Glacier automatically calculates the suction head using input from the Liquid Detector.

Incorrect suction line values or disabling the liquid detector may adversely affect the volume accuracy. Therefore, calibrating the sampler can enhance sample volume accuracy.

To prepare the Glacier for calibration, turn the Glacier on and press the CALIBRATE button. Then follow the steps:

Example 2-1 Calibrating

1.

SUCTION LINE SIZE:
6 mm 9 mm

Select the type of suction line attached to the Glacier. Two diameters are available to choose from: 6 mm ($\frac{1}{4}$ inch) and 9 mm ($\frac{3}{8}$ inch).

2.

SUCTION LINE LENGTH:
7.6 m (0.9–30.2 m)

Measure the length of suction line (not including the strainer or pump tube). If necessary, cut the tubing to the nearest foot or decimeter. Enter this length by pressing the Number buttons, then press the Enter button.

3.

SUCTION HEAD:
3.1 m (0–7.6 m)

Enter the vertical height (refer to Figure 2-3) from the Glacier controller to the top surface of the liquid.

4.

CHECK SAMPLE VOLUME?
YES NO

Select YES to collect a sample for volume measurement. Select NO to skip the remaining steps and return to the Standby display.

**Example 2-1 Calibrating
(Continued)**

5.

```
CALIBRATE VOLUME  
PRESS ↵ WHEN READY!
```

The Glacier waits while you prepare to collect the sample. Pull the lower pump tube from the bulkhead fitting and hold the end over a graduated cylinder. Press the Enter button when you are ready.

6.

```
TAKING 200 ml  
CALIBRATE SAMPLE
```

The Glacier collects the programmed sample volume (section 3.6.5).

7.

```
VOLUME DELIVERED  
200 ml
```

Read the volume of liquid deposited in the graduated cylinder and compared it to the VOLUME DELIVERED. If the volumes match, press the Enter button. If they don't match, type the measured volume using the Number buttons, then press Enter.

Pressing Enter completes the calibration steps. However, the Glacier may note a large difference between the intended volume and the volume you entered. If so, The Glacier displays one more step.

8.

```
___ ml! ARE YOU  
SURE? YES NO
```

(Continued)

Example 2-1 Calibrating (Continued)

If the Glacier displays the screen in step 8, verify that the volume held in the graduated cylinder matches the displayed value. If the numbers match, select YES and press the Enter button. If they don't match, select NO to reenter the measured volume.

Note

Reconnect the lower pump tube to the bulkhead fitting when you have completed the calibration steps.

Figure 2-3 Measuring Suction Head Height

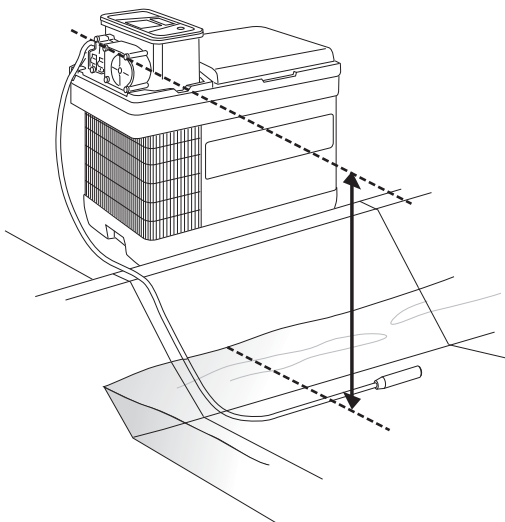

Glacier Transportable Sampler

Section 3 Programming

3.1 Programming Overview

This section shows you how to program the Glacier. In this section you will find:

- *The Glacier Interface*—This explains how you operate the Glacier using the keypad and display (3.2).
- *Operating States*—This explains the many states of operation (3.3).
- *Programming Instructions*—This section provides instructions on One-button Programming and Standard Programming (3.4 through 3.6).
- *Setting the time and date*—This section explains how to set the internal clock (3.7).
- *Sampler Options*—This section lists the available software options and how to enable/disable them (3.8).

3.2 The Glacier Interface

The Glacier is easily programmed and operated from the controller front panel. The front panel holds the liquid crystal display and the keypad. The front panel also includes an internal case humidity indicator.

3.2.1 The Glacier Display

The Control panel holds a 2-column by 20-character liquid crystal display. Through this display, the Glacier reports all of the possible operating states.

The display will also show messages as needed. These messages alert you to unusual conditions or the need for servicing. Messages may alternate with the current display, such as “ERRORS HAVE OCCURRED,” or at the end of a sequence of screens, such as “WARNING: CHANGE PUMP TUBE.”

3.2.2 The Glacier Keypad

The Glacier accepts input from the 18-button keypad. The operating state will determine which buttons are active.

Refer to Section 1 for a description of the keypad buttons.

3.3 Glacier Operating States

The Glacier has many states of operation. States of operation can be classified as either “interactive” or “non-interactive.”

3.3.1 Interactive States

Standby—The display shows “PROGRAM, VIEW LOG,” and the current time and date. This is an interactive state and the Glacier is waiting for your input. You will see that one of the items is blinking; this is the current selection and will be accepted if the ENTER button is pressed. You can change the selected item by pressing the ARROW button.

Program—The display shows programming options or number-entry screens. Again, this is an interactive state through which you can modify the operation of the sampler controller.

Paused—Pressing the STOP button while the sampler is running a program places the Glacier in the Paused state. This is an interactive state where you can choose to view the event log, return to the Run state, or halt the sampling routine.

Time and Date—the display shows “ENTER TIME AND DATE:” This is an interactive state used to set the correct time and date.

3.3.2 Non-interactive States

Off—The display is blank. In this state, a few sampler functions continue to operate, even without its external 12-volt DC power source. An internal battery powers the real-time clock to maintain the correct date and time. When an external 12-volt DC power source is connected, the Glacier will respond only to the ON/OFF button.

Run—The display shows information about the program that it is running. This is typically the current activity, such as “TAKING SAMPLE 10 OF 24,” or when the next event is to occur, such as “SAMPLE 8 OF 96 IN MM:SS.”

Done—The display shows “PROGRAM DONE.” This state reports that the Glacier has finished running the program. Pressing any button will place the sampler in the Standby state.

View Log—The display scrolls through the event log.

3.4 Programming the Glacier

There are two ways to program the Glacier:

- One-button Programming
- Standard Programming

One-button Programming quickly loads program settings from a stored program and runs the sampling routine.

Standard Programming allows you to step through the current Glacier program settings, making any necessary modifications.

3.5 One-button Programming

The One-button Programming feature of the Glacier allows you to load the Stored program settings and run the program in one quick and simple step.



1



2



3

☑ Note

This sequence of buttons must be completed within 10 seconds.

3.5.1 Stored Program

At all times the Glacier holds two programs, the Stored program and the Current program. The Stored and Current program settings may or may not be the same. When you press the GO button, the Glacier runs the Current program settings.

The One-button Programming restores the Current program settings to that of the Stored program.

The Glacier is shipped from the factory with the following stored program settings:

- Time Paced
- 15 Minute Pacing Interval
- 9400 ml Bottle Volume - for 2.5-gallon (10-liter) bottles
- Take 96 Samples - covers a 24-hour time period
- 80 ml Sample Volume
- No Delay to First Sample
- $\frac{3}{8}$ -inch by 25-foot suction line

☑ Note

Re-initializing the Glacier or updating its software will restore the factory program settings. Refer to the *Glacier Manual on CD* for more information on re-initializing the Glacier or updating its software.

3.6 Standard Programming

Standard Programming allows you to step through the current Glacier program settings and make any necessary modifications.

To access the Standard Programming, select Program from the Standby screen and press ENTER.

The seven-step Standard Programming goes through the following settings:

- *Pacing*—Choose from time or flow paced sampling. Flow paced sampling requires an external flow metering instrument (3.6.1).
- *Interval*—Set the pacing interval in minutes or flow pulses (3.6.2).
- *Bottle Volume*—Enter the capacity of the bottle installed in the Glacier base section (3.6.3).
- *Number of Samples* — Set the number of samples to collect or place the Glacier in the Continuous Sampling mode (3.6.4).
- *Sample Volume*—Enter the desired volume to collect at each sample event (3.6.5).
- *Delay to First Sample*—Without a delay the Glacier will always take the first sample when you press the GO button. This programming step allows you to delay the first sample (3.6.6).
- *Suction Line*—Enter the type of suction line in use. This step also includes the

Sample Volume Calibration procedure (3.6.7).

3.6.1 Programming Step 1 – Pacing

The Glacier displays two pacing options—Time Paced and Flow Paced. Select Time to collect samples at uniform time intervals. Select Flow to collect samples based on flow volumes. An input signal from an external instrument is required when you select Flow Paced.

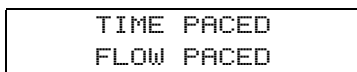

The current selection will be blinking. To program the pacing method:

1. Press the ARROW button to select an option.
2. Press the ENTER button to accept the blinking option. The Glacier loads the option into the current program settings and advances to the next step.

3.6.2 Programming Step 2 – Pacing Interval

After selecting the pacing method in Step 1, the program now needs a pacing interval. A pacing interval is a value that the sampler will “count down” from after each sample event. Time paced programs will count down an interval in minutes using its internal clock. Flow paced programs will count down the number of flow pulses it receives from an external device.

15 MINUTES
BETWEEN SAMPLES

10 FLOW PULSES
BETWEEN SAMPLES

The Pacing Interval display will show “minutes” or “flow pulses” according to the previously selected pacing method.

You can accept the interval by pressing the ENTER button, or change the setting. To change the setting:

1. Enter the new value using the NUMBER buttons. The Glacier will accept intervals from 1 to 9,999.

Note

If you enter an incorrect value with the NUMBER buttons, press the STOP button. The Glacier restores the original value and waits for a new value.

2. Press the ENTER button to accept the new value. The Glacier loads the value into the current program settings and advances to the next step.

3.6.3 Programming Step 3 – Bottle Volume

In this programming step, enter the capacity of the bottle installed in the base section of the sampler. As shown on the display, acceptable values range from 3,500 to 20,000 milliliters.

BOTTLE VOLUME 9400 ml

The Glacier typically uses standard bottles provided by Isco. When using Isco's standard bottles refer to the chart below for recommended values. You will note that the value is less than the total capacity. This reduces the possibility of missed samples due to a Bottle Full error, or spills when the bottle is full.

Bottle Description	Enter this value (in milliliters)...
5-gallon (19-liter) lightweight polyethylene	19000
2.5-gallon (10-liter) glass	9400
2.5-gallon (10-liter) Nalgene	9400
2.5-gallon (10-liter) lightweight polyethylene	9400
2-gallon (7.6-liter) ProPak liner	7000

You may use a non-standard bottle in the Glacier. When entering the non-standard bottle volume, it is advisable to enter a value less than the total volume. Again, this will reduce the possibility of missed samples and spills.

To enter the Bottle Volume:

1. Press the appropriate NUMBER buttons on the keypad. The Glacier requires all four numbers.
2. Press the ENTER button to accept the new value. The Glacier loads the value into the current program settings and advances to the next step.

Cumulative Error – When entering the bottle volume, keep in mind that the actual total volume deposited in the bottle is subject to a *cumulative error*. Cumulative error is caused by slight variations in the repeated sample volumes and the actual volume delivered compared to the programmed volume. (The sample volume repeatability is ± 10 ml.) These variations are repeated as the Glacier collects additional samples, and soon becomes a significant amount of liquid. The example below illustrates this point.

If the sampler consistently places 24 sample volumes of 160 ml (150 ml + a 10 ml variation) in a 3800 ml bottle, the total volume deposited would be 3840 ml. This would overflow the bottle by 40 ml. Again, to avoid possible overflowing, enter a bottle volume that is less than the actual bottle capacity.

The true bottle size can be entered. However, this increases the likelihood that the cumulative error may cause samples to be missed or spilled.

✓ Note

Overfilling the bottle or missing samples can affect your sampling results. In some applications, missed or spilled samples may render the bottle contents to be less than a representative composite sample.

3.6.4 Programming Step 4 – Number of Samples

Enter the number of samples to collect. To enter the number of samples:

```
TAKE 10 SAMPLES  
(1-470)
```

1. Press the appropriate NUMBER buttons on the keypad.
2. Press the ENTER button to accept the new value. The Glacier loads the value into the current program settings and advances to the next step.

Continuous Sampling Mode – The Glacier can be placed in a Continuous Sampling mode. In this mode, the Glacier collects samples without regard for the total number of samples. In continuous sampling mode, samples are collected until the Liquid Detector senses a full bottle condition. (Sample volumes should be greater than 60 ml for the liquid detector to reliably sense this condition.) The Glacier then halts the sampling routine. To enable the Continuous Sampling mode:

1. At the “TAKE XX SAMPLES” display, press the ZERO button.

2. Press the ENTER button. The Glacier is placed in the Continuous Sampling mode and advances to the next programming step.

3.6.5 Programming Step 5 – Sample Volume

Enter the volume to collect at each sampling event. This value must be within the range shown on the Glacier display.

SAMPLE VOLUME 80 ml (10-930)

To enter the sample volume:

1. Press the appropriate NUMBER buttons on the keypad.
2. Press the ENTER button to accept the new value. The Glacier loads the value into the current program settings and advances to the next step.

 Note
--

Sample volumes greater than 60 ml are recommended. This volume is necessary for the bottle full detection to work properly.

3.6.6 Programming Step 6 – Delay to First Sample

Enter the delay to the first sample. The acceptable range of values is from 0 to 9,999 minutes.

1 MINUTES TO FIRST SAMPLE

1. To enter the delay, press the appropriate NUMBER buttons on the keypad.
2. Press the ENTER button to accept the new value. The Glacier loads the value into the current program settings and advances to the next step.

If you enter "0," the Glacier will collect its first sample immediately after you press the GO button. If you enter a value greater than zero, the Glacier will start a delay time count down when you press the GO button. The Glacier collects its first sample when the delay expires. After the first sample, all remaining samples are collected at the programmed Pacing Interval.

3.6.7 Programming Step 7 – Calibrate Sample Volumes

The display alternates between the two displays shown below.

SUCTION LINE: 9 mm BY 7.6 m

PRESS GO TO RUN OR CALIBRATE TO CHANGE

While the two displays alternate, the Glacier is counting down a five-minute time interval. If you do not press a button during this count down, the Glacier times out and automatically runs the current program.

This Suction Line display reports the suction line diameter and length. This information must be correct so that the Glacier can deliver sample volumes as programmed. Verify that the diameter and length match the suction line in use.

If the suction line settings are correct, calibration is not necessary. To skip the calibration, press:

- The GO button to run the program, or,
- The ENTER button to accept the values and return to the Standby state.

If the settings do not match the suction line in use, you must enter new values. Press the CALIBRATE button and proceed with the Calibration steps. See Section 2.10 for complete calibration instructions.

 Note

If your sampling protocol requires the utmost volume accuracy, step through the calibration procedure and check the delivered sample volume. Calibration may improve the Glacier's volume accuracy.

3.7 Setting the Time and Date

Should it become necessary to set the time or date, do the following:

1. From the standby state, press the ARROW button until the time and date is blinking.
2. Press the ENTER button to access time and date entry display. The cursor is waiting for you to enter the current time.

3. Enter the hours with the NUMBER buttons. The hours must be entered in a 24-hour (military time) format. For example, 5:00 p.m. is 17:00 on a 24-hour clock. Press the ENTER button to accept the hour setting and advance the cursor to the minutes.
4. Enter the minutes with the NUMBER buttons. Press the ENTER button to accept the minutes setting and advance the cursor to the day setting.
5. Enter today's date with the NUMBER buttons. Press the ENTER button to accept the date and advance the cursor to the month setting.
6. Enter the number of the month (for example, August = 08) with the NUMBER buttons. Press the ENTER button and the Glacier abbreviates the month and advances the cursor to the year setting.
7. Enter the last two digits of the year (for example, 2002 = 02). Press the ENTER button to accept the year and return to standby.

3.8 Glacier Options

Several software-based options are available for the Glacier.

- *Program Lock*—adds password protection to sampler programming and operation.

- *Program Storage*—store a program for easy recall.
- *Bottle Full Disable*—turn off full bottle detection when using $\frac{3}{8}$ -inch (9-mm) suction lines.
- *Liquid Detector Disable*—turn off the liquid detector for difficult sampling applications.
- *Foreign Languages*—The Glacier can be shipped with foreign language displays.

3.8.1 Program Lock

The Program Lock adds password protection to the sampler operation. When the Program Lock is enabled, you must enter a password before entering the programming mode and before pausing or halting a running program.

The Program Lock is a factory-installed option. This option should be specified at the time of ordering, or you can return the controller to Isco to have the option installed.

```
PROGRAM  VIEW LOG  
hh:mm  ddmmyy  LOCK
```

When the Program Lock function is installed, the LOCK option appears on the Standby display.

The lock option on the Standby display allows you to enable or disable the password protection and to change the password. A review of the lock option displays appears below.

1. Press the ARROW button until "LOCK" is blinking.
2. Press the ENTER button to accept the selection.

```
ENTER PASSWORD:  
XXXXXX
```

3. If the lock is currently enabled you will be asked to enter the password before modifying any settings. The Glacier is shipped from the factory with a default password of "457." Press the NUMBER buttons to enter the password and the display returns an asterisk for each button pressed. Press the ENTER button to continue.

```
USE PROGRAM LOCK?  
YES NO
```

4. The next display allows you to enable or disable the password protection. Selecting YES turns the password protection on and advances to step 5. Selecting NO turns the protection off and the Glacier returns to the Standby state.

```
CHANGE PASSWORD:  
YES NO
```

5. The Glacier queries "CHANGE PASSWORD?". If you select YES the Glacier advances to the password entry displays in steps 6 and 7. If you select NO, the Glacier

retains the existing password and returns to the Standby state.

ENTER NEW PASSWORD:

6. Use the NUMBER buttons to enter the new password. A valid password uses any combination of numbers 0 through 9. The password can use as many as five digits. As you enter the numbers, the Glacier displays asterisks to “hide” the password. Press the ENTER button to accept the password and advance to step 7.

REENTER PASSWORD:

7. The Glacier asks you to confirm the password by re-entering it. Again, use the NUMBER buttons to enter the password and then press the ENTER button to accept it. When you successfully confirm the password, the Glacier returns to the Standby state. If the confirmation is unsuccessful, the Glacier notifies you that the passwords are different and returns you to step 6.

While a program is running, it is possible to halt the operation of the pump without the password. Pressing the STOP button will halt the current sample and prompt you to ENTER PASSWORD. Entering the correct password places the Glacier in the Paused state. If the password is incorrect, or if there is no password

entered within 60 seconds, the sampler resumes the count down to the next sample. In any case, the Glacier logs the missed sample as USER STOPPED PUMP.

 Note

Any samples that would have been taken while the sampler is waiting for password entry will be logged as missed due to PROGRAM PAUSED.

3.8.2 Storing a Program

Glacier is shipped with default program settings as its stored program. You can overwrite the stored program settings with your own program by using the Program Store function.

To store a program:

1. Modify the current program using the standard programming.
2. Press 78673.↓ while in the Standby state. The Glacier displays “PROGRAM STORED” for four seconds.

The current program settings are now saved in the Glacier memory as the Stored Program. In the field, recall and run the program with the One-button programming procedure.

 Note

The stored program settings are held in the sampler's memory until the software is updated or the Glacier is re-initialized. Either of these actions will restore the factory default program settings. Refer to the *Glacier Manual on CD* for more information on re-initializing or updating the Glacier.

3.8.3 Disable Bottle Full Detection

The bottle full detection feature can be disabled.

To disable the bottle full detection:

1. Press 3855.␣ while in the Standby state.
2. The Glacier displays “BOTTLE FULL DETECT?” Select NO to disable bottle full detection. Select YES to use bottle full detection.

BOTTLE FULL DETECT? YES NO

3. Press the ENTER button to accept the blinking option and the Glacier returns to the Standby state.

 Note

Bottle full detection is always disabled when using 1/4-inch (6-mm) suction line.

3.8.4 Liquid Detector Disable

It is possible to disable the operation of the liquid detector. Typically, there are only two applications where this may be beneficial—collecting samples that include a large amount of foam, or collecting samples from pressurized lines.

Keep in mind that disabling the liquid detector will affect the sample collection in several ways. The most significant effect is the sample volume accuracy. Although you can calibrate the sample volumes at a fixed suction head, the

Glacier will be unable to compensate for varying stream levels. Secondly, the Glacier will not be able to detect a full bottle. A disabled liquid detector may increase the risk of overfilling the bottle. Lastly, the Glacier will not be able to detect and log missed samples caused by NO LIQUID or NO MORE LIQUID.

To disable the liquid detector:

1. Press 5390.␣ while in the Standby state.

USE LIQUID DETECTOR
YES NO

2. The Glacier displays “USE LIQUID DETECTOR?”. Select NO to disable the liquid detector. Selecting YES restores the operation.
3. Press the ENTER button to accept the blinking option and the Glacier returns to the Standby state.

3.8.5 Foreign Language Displays

The Glacier is shipped with English language displays unless a different language is specified at the time of ordering. The following languages are available as factory-installed options:

- French
- German
- Italian
- Spanish

Glacier Transportable Sampler

Section 4 Operation

4.1 Overview

This section shows you how to run Glacier programs. In this section you will find:

- Starting Programs (4.2)
- Start time Delays (4.3)
- Sampler Inhibiting (4.4)
- Run State Displays (4.5)
- The Sample Collection Cycle (4.6)
- Refrigeration Control (4.7)
- Pausing or Stopping a Program (4.8)
- Program Completion (4.9)
- Post-sampling Activities (4.10)
- Viewing the Log (4.11)
- Text Reports using Isco's SAMPLINK™ software (4.11.2)
- Errors (4.11.1)
- Taking Grab Samples (4.12)

4.2 Starting a Program

You can easily start the Glacier operation by pressing the GO button. Pressing this button runs the current program.

The Glacier operation can also be started with the one-button programming sequence. This action will load the stored program settings as the current settings and run the program.

Generally when you start a program, the Glacier will attempt to take its first sample at the start time—unless the first sample is delayed (4.3) or the Glacier is inhibited (4.4).

4.3 Counting Down Delay Times

After pressing the GO button, the Glacier will immediately take a sample regardless of whether it is a time or flow paced program. However, the Delay to First Sample setting can be used to start the sample collection up to 9,999 minutes after you press Go.

FIRST SAMPLE IN mmm:ss

If the Delay to First Sample setting is one or greater, the Glacier must count down from the programmed value before drawing its first sample. During this delay, the First Sample count-down screen is displayed.

4.4 Sampler Inhibit

Before the Glacier takes its first sample, it checks the inhibit line of the Flow Meter connector. If the Glacier detects a logic low (grounded) level, it will suspend the program until the external device returns the line to a logic high (or open) level.

SAMPLER
INHIBITED

While in this state, the Glacier will display the SAMPLER INHIBITED screen.

The inhibit line allows an external device, while monitoring parameters of interest, to control the sampler operation. Compatible Isco devices can be configured to inhibit a sampler until a parameter meets user-defined conditions. For example, a 4200 Flow Meter with a Model 201 pH/Temperature Module can be programmed to suspend sample collection until the stream temperature exceeds 100° F.

When the external device releases the inhibit, the Glacier will:

- immediately take the first sample
- reset the time or flow pacing interval and begin counting down
- latch the inhibit signal

Latching the inhibit signal means that the Glacier will ignore any later inhibit signals from an external device. Once the Glacier

collects its first sample, its operation will continue until the program is done.

The Glacier will not “store” samples while it is inhibited. The Glacier takes no action at all when it counts down a complete time or flow-pacing interval. Time or flow pacing intervals that elapse while the Glacier is inhibited are simply ignored.

4.5 Run State Displays

The Glacier updates its display while it is running a program so that you can monitor the status. The Run State displays are described in the sections 4.5.1 through 4.5.3.

4.5.1 Collecting a sample –

As the Glacier goes through a sample collection cycle it displays the current sample number.

```
TAKING SAMPLE
xxx OF yyy
```

If the Glacier is programmed to collect a fixed number of samples it will report which of the total number of samples it is now collecting.

```
TAKING SAMPLE
xxx
```

If the Glacier is operating in the continuous sampling mode (3.6.4) it will report only the current sample number.

4.5.2 Waiting to sample –

The Glacier counts down the pacing interval while it is waiting for the next sample collection cycle.

```
SAMPLE xxx OF yyy  
IN mmm:ss
```

For time paced sample programs, the Glacier will count down the time to next sample.

```
SAMPLE xxx OF yyy  
IN zzz FLOW PULSES
```

For flow paced sample programs, the Glacier will count down the number of flow pulses to the next sample.

If the Glacier is in the Continuous Sampling mode, it only displays the next sample number.

4.5.3 Errors –

If the Glacier encounters an error while running a program, the “ERRORS HAVE OCCURRED” display alternates with the pacing interval countdown display.

```
ERRORS HAVE  
OCCURRED
```

Note

You can pause a running program to review the log and determine the cause of the error. See section 4.8.

4.6 Sample Collection Cycle

Each time the Glacier collects a sample (programmed or grab) it runs the pump through a complete sampling cycle. The cycle consists of three actions - Pre-purge, Fill, and Post-purge.

4.6.1 Pre-purge

As the Glacier waits to collect a sample, some liquid will tend to enter the suction line and debris may collect around the strainer. The pre-purge runs the Glacier pump in reverse to force air down through the suction line and strainer. This action will flush the water from the suction line and clear any debris near the strainer. The duration of the pre-purge is automatically calculated by the Glacier based on the programmed suction line settings.

4.6.2 Fill

After a pre-purge, the Glacier pump changes its direction to draw liquid into the suction line. The liquid travels up through the suction line and the pump tube where it then passes through the liquid detector and peristaltic pump. The liquid is transferred to the discharge tube via the bulkhead fitting. The discharge tube deposits the liquid into the bottle. The duration of the fill is controlled by the Glacier using input from the programmed volume and suction line settings, and the liquid detector. The Event Mark pin of the Flow Meter connector goes to a high level (+12 Volts DC) at the beginning of the fill and remains high until the fill is complete.

4.6.3 Post-purge

After the fill, the Glacier again reverses the pump direction to force air down through the suction line. This action clears the entire liquid path to prevent cross-contamination. During the post-purge, the Glacier will determine if the bottle is full. Since a short length of discharge tube extends inside the bottle, an over-filled bottle will allow liquid to be drawn back into the discharge tube. If the liquid detector finds that this excess amount of liquid is being returned through the liquid path, the Glacier stops the program and indicates that the bottle is full. The duration of the post-purge is automatically calculated by the Glacier based on the programmed suction line settings.

4.7 Refrigeration Control

The refrigeration system will not operate until the completion of the program's first sample. Even if the first sample results in an error condition, the refrigeration system will be activated. Likewise, the refrigeration system will also be re-activated once power is restored after a power failure.

Once activated, the refrigeration control will remain activated until the sampler is shut off, or a new program is run. The refrigeration control will regulate the operation of the cooling system to maintain the sample at a target temperature of 3° C.

Note

When using the refrigeration control, the temperature sensor should be placed inside the composite bottle, resting at the bottom of the container.

4.8 Pausing or Stopping a Program

Press the STOP button to pause a running program. The Glacier will display the paused options screen.

RESUME IN	m:ss
VIEW LOG	HALT

The screen displays three options - RESUME, VIEW LOG, and HALT.

- *Resume*—select this option to return to the running program. When the Glacier enters the paused state, it starts a five-minute idle time-out. If you do not press a button within five minutes, the Glacier will automatically resume the running program.
- *View Log*—select this option to scroll through the log.
- *Halt*—select this option to stop the program. Once you stop a program, it cannot be resumed. To run a program the Glacier must be restarted.

Use the ARROW button to select an option. When the desired option is blinking, press the ENTER button.

✓ Note

The Glacier continues to count down the pacing interval while it is paused. Keep in mind that if the count reaches zero the Glacier will not take a sample. It records this as a “MISSED SAMPLE - PROGRAM PAUSED” in the log.

4.9 Program Completion

A running program will end in one of three ways:

- *Program Completed*—The Glacier has taken all of the programmed samples.
- *Program Halted*—Stopped by the user.
- *Bottle Full*—The Glacier detected a full bottle and stopped the program.

4.10 Post-sampling Activities

Typical post-sampling activities include:

- Recovering the sampler (4.10.1)
- Preparing the sample bottle to return to the lab (4.10.2)
- Viewing the log (4.11)
- Preparing the Glacier for reuse (2.1)

4.10.1 Recovering the Sampler

When the Glacier completes the program, you may need to move it to a location that allows you easily gain access to its contents. If you must move the sampler keep the following in mind:

- A Glacier with a full sample bottle may weigh over 100 pounds (45 kg), excluding the power source.
- The Glacier must be kept level to avoid spilling the bottle's contents.

4.10.2 Preparing the Full Sample Bottle

To prepare a full bottle to return to the lab, open the refrigerated compartment and replace the bottle cap with the cap provided for transporting. Then, lift the bottle out of the base. At this point, it is a good idea to label the bottle with the time, date, and site, along with other pertinent information.

The bottle may also be returned to the lab in the Glacier. Ideally, the Glacier would be loaded into a vehicle and then connected to 12 VDC power to keep the sample at 3° C. Connect cable 480-0199-00 with the cigarette lighter plug may be used for this purpose. When transporting the bottle inside a powered Glacier, do not replace the bottle cap and leave the temperature sensor at the bottom of the sample container.

4.11 Log

The log is a recorded history of the last or currently running program. The Glacier records key program events, such as start and stop times, and exceptional events, such as power failures or missed samples.

The log can be viewed by selecting the “VIEW LOG” option at the Standby or Paused state displays.

As you begin to view the log, the Glacier reports the following:

- The number of samples it has collected
- Missed samples. The Glacier skips this display if there are none to report. If there are some, the Glacier will report the number of samples missed and the cause. Possible causes are:
 - No liquid detected
 - No more liquid
 - Power fail
 - User stopped pump
 - Paused
 - Pump jammed
 - Program halted
 - Bottle full
- Program start time
- Current status. One of the following will be reported:
 - Program completed
 - Program halted
 - Bottle full
 - Program paused (with number of samples remaining)

- Power lost. If power was lost while the Glacier was running the program, it reports the times it was lost and restored. This will be reported whether a sample was missed or not.
- Last sample volume calibration date
- Last programmed date
- Clock set at (time and date)
- Sampler ID and software revision number
- Pump tube warning if the pump counts exceed 500,000. When the Glacier displays this message, replace the pump tube to prevent failures (see 5.4). After you have replaced the pump tube, reset the pump count to zero to clear this message.

 **Note**

Pressing the GO button clears the log. The only information that the Glacier retains from program to program is the Last Calibration Date, Last Programmed Date, Clock Set, and the Sampler ID and Software Revision. The Glacier also keeps the current pump count value which is used to determine when to display the pump tube warning. Re-initializing the Glacier or updating the software will also clear the log.

4.11.1 Errors

The Glacier can detect program errors or conditions that have caused it to miss a sample. If the Glacier encounters an error condition and is still running a program, it alternates the message below with the current display.

The Glacier also makes an entry in the Log, which can be viewed later to determine the cause. Possible log entries are:

- No liquid detected—The Glacier did not detect any liquid.
- No more liquid—The Glacier did detect liquid during the fill cycle, but it stopped detecting liquid before a complete sample volume was collected.
- Power fail—Power was lost and caused the Glacier to miss a sample.
- User stopped pump—The user pressed the STOP button while the Glacier was collecting a sample.
- Paused—The Glacier was in the paused state when a sample was to have been initiated.
- Pump jammed—The Glacier pump jammed during a sample collection cycle.
- Program halted—Remaining samples were not collected because the program was halted.
- Bottle full—Remaining samples were not collected because the Glacier detected a full bottle.

4.11.2 Viewing Log Reports using Isco SAMPLINK software

Text reports are available using Isco's SAMPLINK™ software which may be ordered as an accessory. The text reports consist of the VIEW LOG screens, followed by daily summaries of the stored temperature data. Daily summaries include the calendar day's average temperature, minimum and maximum temperature, hourly averages, and a simple bar graph representing the hourly averages. The Glacier stores up to 10 days of sample temperature data recorded at one-minute intervals.

To retrieve the reports from the Glacier:

1. Connect a computer to the Glacier with the connect cable, Isco P/N 60-2954-021.
2. Start SAMPLINK. SAMPLINK is a DOS program, therefore you must run it from a DOS prompt. Depending on which version of Microsoft® Windows® you are running, type either "cmd" or "command," from the Run dialog (Windows Start>RUN). At the DOS prompt representative of SAMPLINK's home directory, type "SL".
3. From the SAMPLINK Screen select the appropriate COM port. SAMPLINK will retrieve the first page of the report.
4. To retrieve additional pages, Type "N" to view the next page, or "C" to retrieve all of the pages continuously.

For additional instructions please refer to the SAMPLINK instruction manual.

4.11.3 Viewing Log Reports using a Terminal Program

Text reports can also be viewed using a computer terminal communications program such as HyperTerminal which is included with the Microsoft® Windows® operating system.

To retrieve the reports from the Glacier:

1. Connect a computer to the Glacier with the connect cable, Isco P/N 60-2954-021. The Glacier must be turned on for the remaining steps.

2. Start the terminal program.

Communications should be configured for:

- A baud rate up to 19,200 bits per second
- Eight data bits
- No parity
- One stop bit
- No hardware flow control.

3. Connect to the Glacier by pressing the “?” key on your computer keyboard. Repeat this at one- or two-second intervals until the Glacier responds with a sampler identification string and a “?” prompt. The Glacier is ready to receive a command.

4. Type a command and press the Enter key on your computer keyboard.

Available commands are:

- RESULTS - With this input command the Glacier will respond with all of the VIEW LOG screens.

- **REPORT** - With this input command the Glacier will respond with all of the VIEW LOG screens followed by the daily summaries of temperature data.
- **SUMMARY** - The Glacier will return only the daily summaries in the report.

Entering these commands will display the requested log report and terminate the communication session. If a second report is needed, re-establish communications by pressing the “?” key again (step 3).

One additional command is available:

- **DATA** - The Glacier will report the stored temperature data for the most recent sampling program. The temperature data output format is comma-separated-values, so that you can easily import the data into your spreadsheet or database applications.

The Glacier does not terminate the session after the DATA command. When you are done with DATA reports, press the “Q” key on your computer keyboard to terminate the communication session with the Glacier.

4.12 Grab Samples

Grab samples let you take a single sample on demand, collecting the sample in an external container. You can collect a grab sample while the Glacier is running a program, paused, or in standby.

To collect a grab sample:

1. Press the GRAB SAMPLE button.

```
SAMPLE VOLUME:
200 ml (10-9990)
```

2. The Glacier asks how much liquid to collect. Using the NUMBER buttons, enter the desired volume (in ml). Press the ENTER button to continue.

```
GRAB SAMPLE
PRESS ↓ WHEN READY!
```

3. The Glacier waits for you to prepare to collect a grab sample. Pull the lower pump tube from the bulkhead fitting. Hold the end of the tube over a container. Press the ENTER button when you are ready.

```
TAKING 200 ml
GRAB SAMPLE
```

4. The Glacier goes through a complete sample collection cycle and deposits the requested amount of liquid in the container.
5. Return the pump tube to the bulkhead fitting.

If a grab sample is taken while a program is running, it is not counted as part of the number of samples.

If you interrupt a running program to collect a grab sample and miss a programmed sample event, it is logged as "PROGRAM PAUSED" error.

Glacier Transportable Sampler

Section 5 Maintenance

5.1 Overview

This section contains instructions necessary to perform routine and preventive maintenance on the Glacier and its related components. The topics are outlined below.

Routine maintenance - at user determined intervals

- Cleaning (5.2)
- Defrosting the refrigerator (5.3)
- Pump tube replacement (5.4)
- Discharge tube replacement (5.5)
- Battery and power pack servicing (5.6)

Preventive maintenance - as needed

- Replacing the internal desiccant (5.7)

Problem resolution

- Troubleshooting and self-diagnostics (5.8)
- Contacting Isco for assistance (5.9)
- Other resources (5.10)

5.2 Cleaning

This section contains topics that provide instructions for cleaning the Glacier and its components.

5.2.1 Cleaning the Glacier Exterior

The Glacier controller, refrigerator exterior, and refrigerated compartment may be cleaned with warm soapy water and a rag. Never use acids or solvents to clean the Glacier. If there is excessive dirt and debris, the Glacier may be hosed off with water. Do not use a pressure washer; this may force water past the protective seals. Water that has collected in the refrigerated compartment can be removed by mopping it up with towels, or by briefly tipping the Glacier over.



CAUTION

Positions other than the Glacier's normal upright position will drain the lubricant away from the refrigerator compressor. Operation without adequate lubrication may permanently damage the refrigeration system. If the Glacier is turned over for more than a few seconds, the Glacier's refrigeration system must not be operated for at least one hour after returning the Glacier to its upright position.

5.2.2 Cleaning the Bottles

The Nalgene, polyethylene, and glass bottles have a wide mouth to facilitate cleaning. Wash them with a brush and soapy water, or use a dishwasher. Glass bottles may be autoclaved.

The 2-gallon (7.6-liter) ProPak™ system was developed by Isco to offer the greatest convenience in preparing sample containers for re-use. Simply remove the used liner and place a new one in the holder. Used ProPak liners can be disposed of or recycled. When necessary, the holder can be washed with warm soapy water or placed in a dishwasher.

5.2.3 Cleaning the Suction Line and Tubing

The suction line, pump tube, and discharge tube can be cleaned by placing the end of the suction line in a cleaning solution. Press the Grab Sample button to pump the solution through the delivery system. When the delivery system is clean, repeat the pumping with clean water to rinse the lines. If any of these items are severely contaminated, they should be replaced.

The strainer can be cleaned with a brush and soapy water.

5.2.4 Cleaning the Temperature Sensor

The temperature sensor may be cleaned with a mild detergent. Using a protective sleeve is a practical alternative to cleaning the temperature sensor between each sampling program. Teflon sleeves are part of a Priority Pollutant Sampling Kit. Call the factory for more information.

 **Note**

For critical sampling applications, consider replacing the suction line, pump tube, and discharge tube. Replacement eliminates the possibility of any cross contamination from previous sampling sites.

5.3 Defrosting the Glacier Refrigerated Compartment

Defrosting the refrigerator compartment may be necessary, depending on the humidity of its operating environment. If ice forms on the walls of the interior compartment, never use sharp objects to remove it. Instead, simply remove power and allow the ice to melt. Mop up the ice-melt with a towel, or drain it by briefly tipping the Glacier over.

 **CAUTION**

Positions other than the Glacier's normal upright position will drain the lubricant away from the refrigerator compressor. Operation without adequate lubrication may permanently damage the refrigeration system. If the Glacier is turned over for more than a few seconds, the Glacier's refrigeration system must not be operated for at least one hour after returning the Glacier to its upright position.

5.4 Replacing the Pump Tube

The pump tube is subject to wear during pump operation. It should be replaced when the Glacier displays the pump tube warning at 500,000 pump counts, or when inspection of the

tube reveals any cracks along its side. The factory set value of 500,000 pump counts will deliver approximately 500 samples of 200 ml each, using a $\frac{3}{8}$ -inch by 10-foot suction line at a 5-foot suction head.



CAUTION



Moving parts can cause injuries. Remove power before replacing the pump tube.

5.4.1 Removing the Tube

To remove the pump tube:

1. Disconnect the power from the Glacier.
2. Disconnect the suction line and pull the pump tube from the bulkhead fitting.
3. Loosen the two thumbscrews and remove the liquid detector cover.
4. Loosen the four thumbscrews and remove the pump housing cover.
5. Pull the pump tube out of the pump housing. Rotating the pump rollers will help free the tube.
6. Clean the inside of the pump housing if necessary. Debris can be brushed from the inside of the pump housing, its cover, and rollers. The interior surfaces may be wiped clean with a damp rag.

Figure 5-1 Liquid detector cover removed



Figure 5-2 Pump housing cover removed



Isco replacement pump tubes are marked with two black bands. These bands are used to correctly locate the tubing in the liquid detector and the pump. Position the pump inlet, or short end, in the upper groove of the liquid detector. The band should be placed at the outer edge of the liquid detector. Replacement pump tubes, P/N 60-2964-013, are available from Isco.

 Note

If you are cutting replacement tubes from bulk Silastic tubing, cut the length to 30.25 inches (770 mm). Since the bulk tubing will not have bands to mark the correct position, ensure that 18.25 inches (490 mm) of tubing is inside the liquid detector and pump, and that the tube is not kinked where it fits over the bulkhead fitting.

5.4.2 Replacing the Tube

To replace the pump tube:

**CAUTION**

Moving parts can cause injuries. Remove power before replacing the pump tube.

1. Disconnect the power from the Glacier.
2. Slip the new pump tube under the pump rollers. Rotating the rollers as you do this will help to slide the tube into the pump.
3. Position the pump tube by aligning the bands at the outer edge of the liquid detector.

4. Replace the liquid detector and pump housing covers. The thumbscrews should be fully hand-tightened.
5. Connect the pump outlet end to the bulkhead fitting. Connect the suction line to the pump inlet.
6. Reconnect the power.

5.4.3 Resetting the Pump Tube Warning

After changing the pump tube, the pump tube warning should be cleared by resetting the pump counts to zero. To do so:

1. From the main (standby) screen, select VIEW LOG.

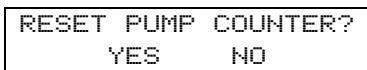

2. Press the ENTER button until the RESET PUMP COUNTER? screen is displayed.
3. Use the ARROW buttons to select YES, then press the ENTER button.

5.4.4 Optimizing Pump Performance

The peristaltic pump and tube will perform the best when you:

- Use Isco replacement pump tubes or bulk tubing.
- Install the tube properly, aligning the inside edges of the bands with the outside edges of the liquid detector.

- Follow the natural curve of the pump tube when fitting the tube inside the pump housing.
- Use the shortest possible length of suction line.

5.5 Replacing the Discharge Tube

The discharge tube does not “wear out” under normal circumstances. However, some sampling protocols may require new tubing, or that the tubing be cleaned, before running each program.

To replace the discharge tube:

1. Remove the discharge tube from the bulkhead fitting.
2. Slide the discharge tube out of the bottle cap.
3. Push the end of the new discharge tube onto the bulkhead fitting.

Replacement tubes for the 5-gallon and 2¹/₂-gallon (19- and 10-liter) lightweight polyethylene bottles use a 5¹/₄-inch (135 mm) long tube.

Replacement tubes for the 2¹/₂-gallon (10-liter) Nalgene and glass bottles, and the ProPaks use an 11¹/₄-inch (285 mm) long tube.

4. Insert the end of the discharge tube into hole in the bottle cap.

☑ Note

The amount of tubing that should extend into the bottle will depend on the programmed sample volume (see section 3.6.5). For the bottle-full detection to work properly, the volume above the discharge tube end must be greater than the programmed sample volume.

The 5-gallon bottle is equipped with a barbed tubing port. Use this port only when bottle-full detection is not needed.

Figure 5-3 Discharge Tube and Tube Guide



5.6 Servicing Batteries

If you are using a battery to power the Glacier, Isco recommends that you install a freshly charged battery before starting each program.



CAUTION

Never charge the battery while connected to the Glacier. Over-voltages could damage the electronics.



CAUTION

Only use Isco battery cables 60-2964-021 or 480-0199-00 to connect the Glacier to a DC power source. The cable length and fusing protect you and the equipment from over-current conditions and the risk of fire.



Note

Battery capacity will degrade after repeated use, eventually requiring replacement. Batteries that are no longer suitable for use should be disposed of according to governing regulations. Check with your battery distributor to see if they will accept the battery as part of its reclamation/recycling program. Keep in mind that a refund may be offered if the old battery is exchanged for a new one.

When purchasing a replacement battery, first consult the *Battery Selection Guide* in the *Glacier Manual on CD*, to determine the correct capacity.

5.7 Replacing the Internal Desiccant

The Glacier uses a bag of desiccant to protect its internal components from moisture damage. When the internal case humidity exceeds 30%, the desiccant should be replaced. The internal case humidity is shown on the indicator visible through the front panel label. The indicator turns pink or white when the humidity level exceeds the printed value. Ideally, all three sections of the indicator should be blue.

If the 20 and 30% sections are pink or white, replace the desiccant. Complete instructions for replacing and regenerating the desiccant can be found in the *Glacier Manual on CD*.

5.8 Glacier Troubleshooting

If you are experiencing problems with the Glacier, contact Isco's Repair Service Department. Simple difficulties can often be diagnosed over the telephone. Before contacting Isco however, take a few moments to ensure that several common problems are first eliminated.

- Ensure that the power supply is adequate. Low power can cause a variety of problems. Simply replacing the battery with a freshly charged unit can correct many faults.
- Ensure that the liquid delivery system is in good condition. The tubing should be free from leaks caused by pinholes or

cracks. Ensure that the tubing is not plugged by debris.

- Clear debris away from the end of the strainer and ensure that it is submerged deep enough to supply liquid for the entire fill portion of the sampling cycle.

If the cause of the problem cannot be determined, the Glacier self-diagnostics routine can be used to test the sampler's functions. Complete instructions for the self-diagnostics routine can be found in the *Glacier Manual on CD*.

5.9 Contacting Teledyne Isco for Assistance

Phone: (800) 228-4373
(USA, Canada, and Mexico)
(402) 464-0231
(Outside North America)

Tech Support: (866) 298-6174

Fax: (402) 465-3022

Email address: info@isco.com

Website: www.isco.com

General correspondence:

Teledyne Isco, Inc.
P.O. Box 82531
Lincoln, NE 68501-2531

5.10 Other *Glacier Manual on CD* resources

The Glacier Manual on CD also includes:

- Specifications
- Return instructions
- Software update information
- A listing of replacement parts
- Accessories for the Glacier
- Battery Selection Guide
- Material Safety Data Sheets (MSDS)
- CE Declaration of Conformity
- Warranty Information